



**DEFEKTY
BUDOV
2023**



Fotovoltaika na střechách s plechovou krytinou

Miroslav OUDES

PREFA Aluminiunprodukte s.r.o., technický poradce, M: +420 602 531 433, E: miroslav.oudes@prefa.com



Systemová řešení při kotvení panelů ...





Komplexní systémové řešení výrobce





Komplexní systémové řešení výrobce





Komplexní systémové řešení výrobce





Nabídka na trhu „systémových řešení“







„cena je dána výškou a délkou prvku“



Google

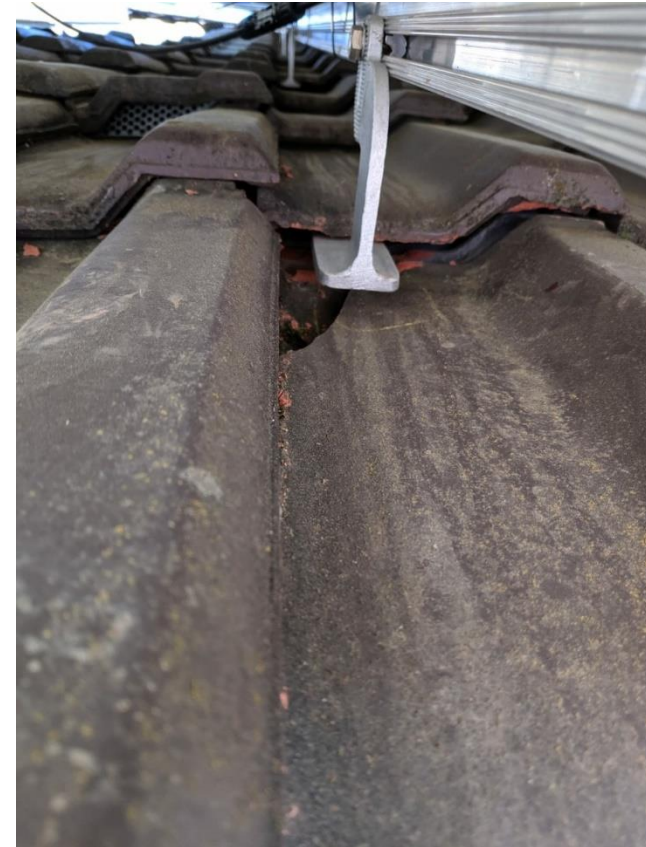
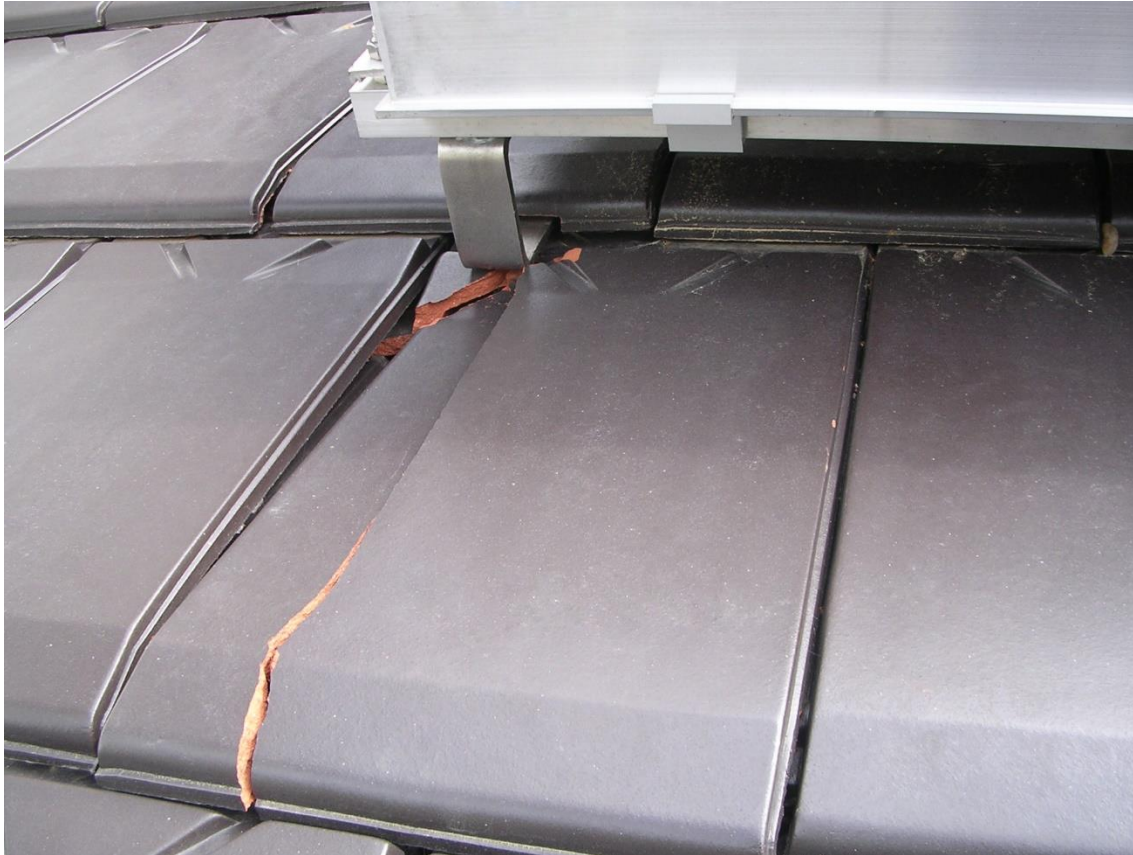

Google

Je toto také „systémové řešení“?

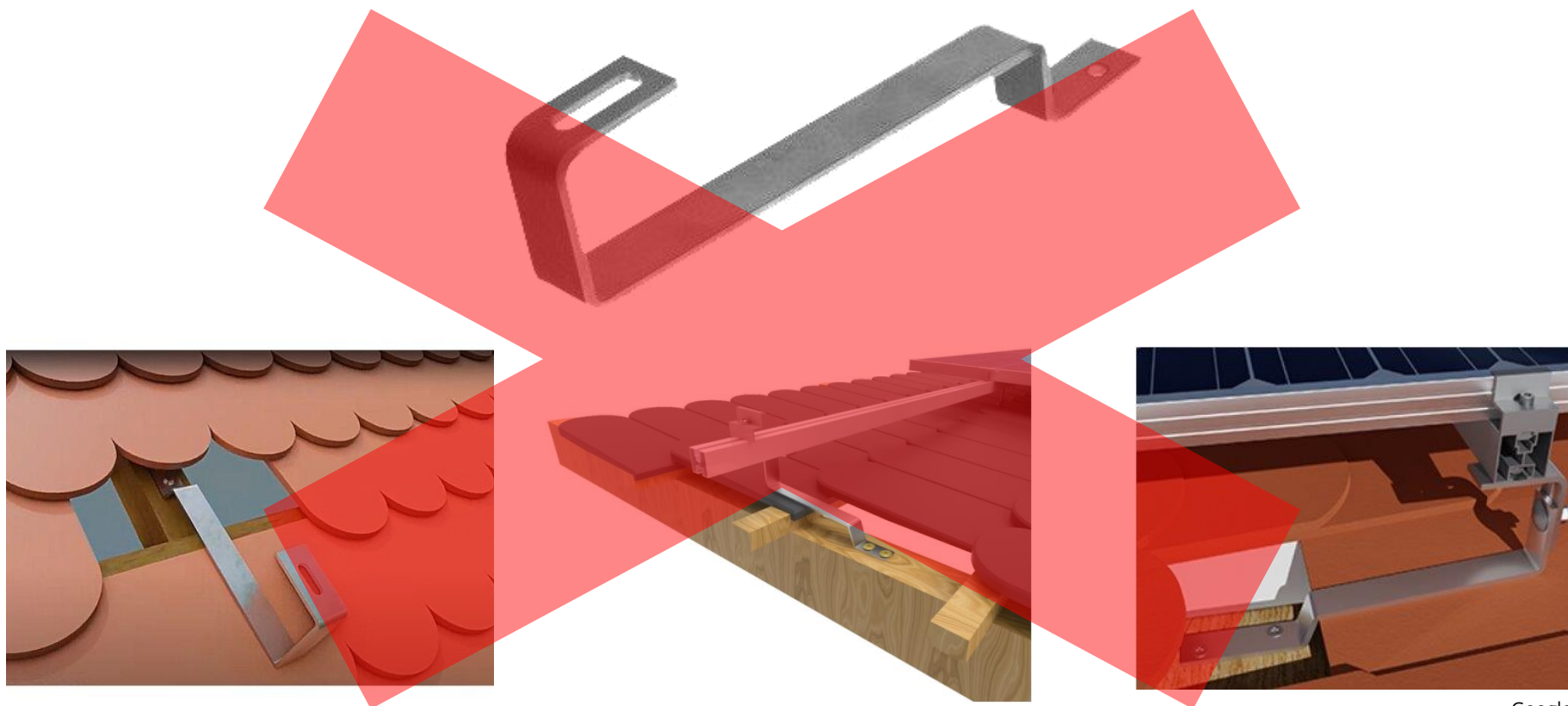

Google

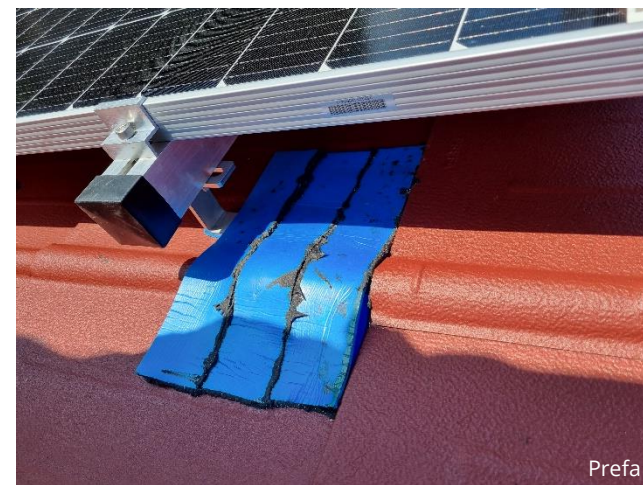

Prefa





Systemová řešení na drážkových krytinách







Komplexní systémové řešení





Komplexní systémové řešení



Prefa



Systemová řešení na „taškových“ plechových krytinách



Systemová řešení na „taškových“ plechových krytinách

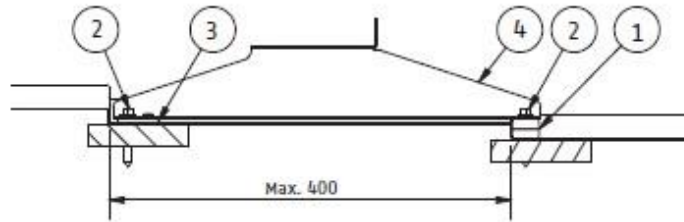
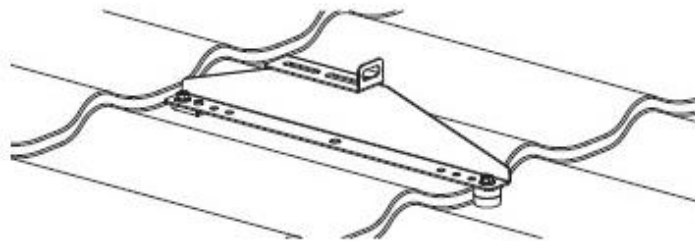

Ruukki

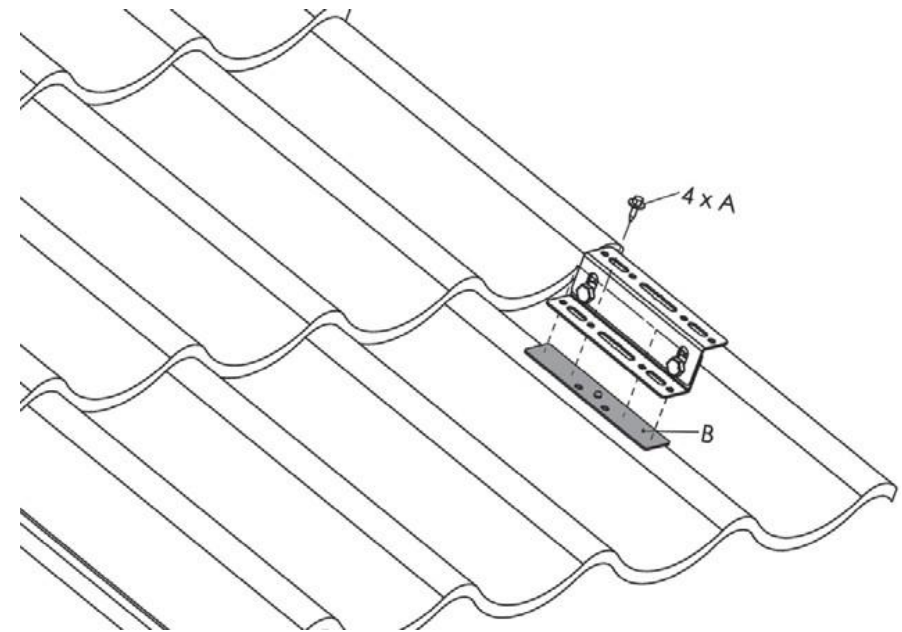

Satjam

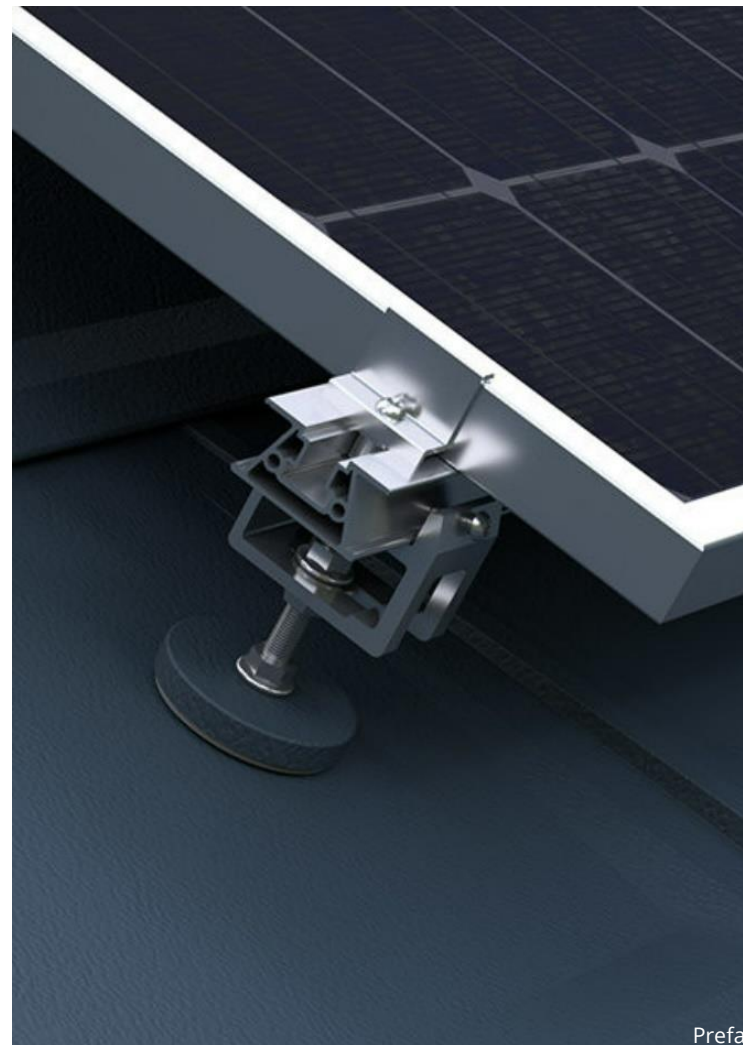
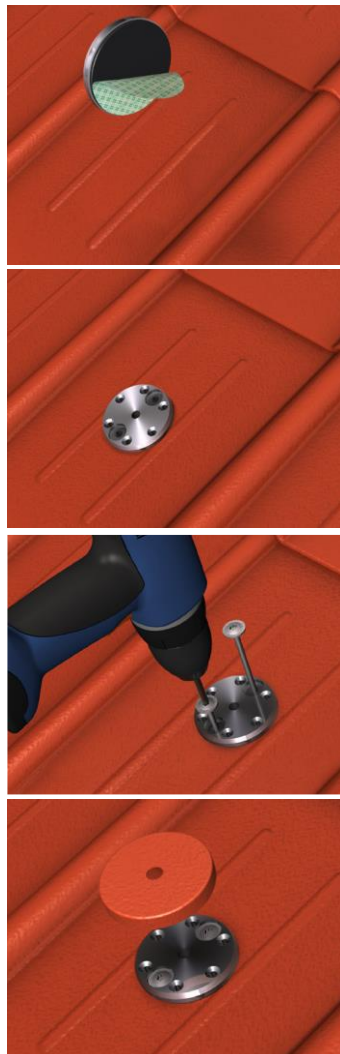



Komplexní systémové řešení





Komplexní systémové řešení





1. Držák solárního panelu **Vario**
2. Držák solárního panelu **Prefalz Vario**
3. Držák solárního panelu **Sunny**



Integrovaný solární systém



Prefa



Integrovaný solární systém



Prefa



Integrovaný solární systém





Integrovaný solární systém





Vývoj solárního systému COLOR

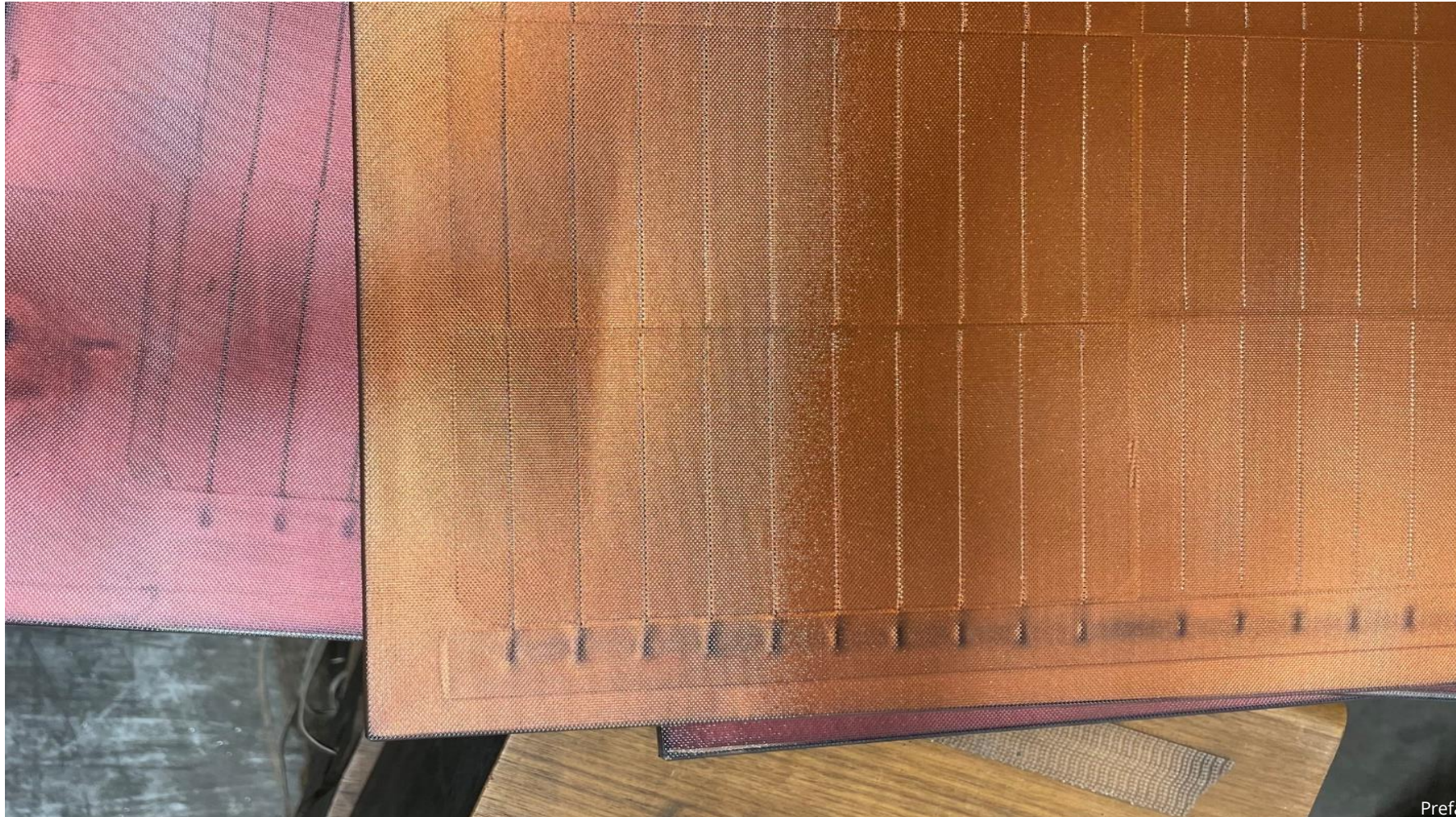



Thank you for your attention!
Děkuji za pozornost!

Miroslav OUDES

miroslav.oudes@prefa.com

ČKAIT



**Sdružení výrobců pro
ploché střechy**



**DEFEKTY
BUDOV
2023**

DEFEKTY BUDOV 2023 | 23. 11. 2023 | VŠTE v ČESKÝCH BUDĚJOVICÍCH | ČESKÁ REPUBLIKA